

MATERIALS

HOUSING: HI-TEMP. PLASTIC (UL 94V-0)
 SHELL: SUS, NICKEL PLATING
 TERMINAL: COPPER ALLOY, GOLD PLATED

SPECIFICATION

CURRENT RATING: 1.8 AMP MAX (ONLY PIN 1, 5), OTHER 1 AMP MAX
 DIELECTRIC WITHSTANDING: 100V AC FOR ONE MINUTE
 CONTACT RESISTANCE: 30m OHMS MAX
 INSULATION RESISTANCE: 100M OHMS MIN AT DC 500V
 OPERATION TEMPERATURE: -25°C~+85°C

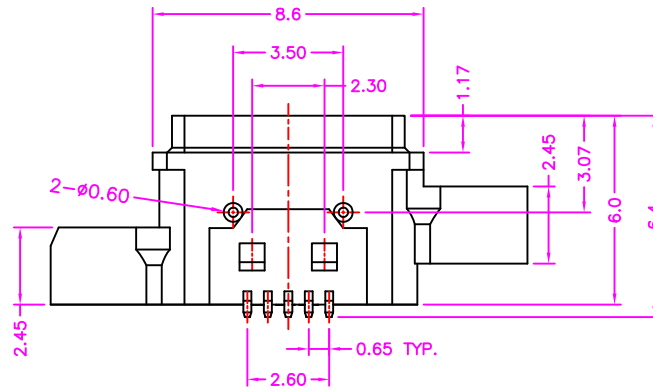
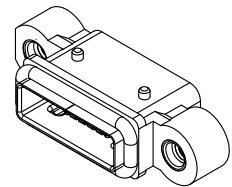
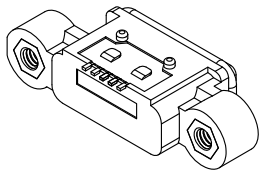

PART NUMBER:

BUSUV - 0 5 * - 1 2 1 *

SERIES

NO. OF POS.

O-RING OPTION
 BLANK: WITHOUT O-RING
 R: WITH O-RING

CONTACT PLATED OPTION

TAPE REEL PACKAGE

- 1: GOLD FLASH
- 3: 3u" GOLD
- 5: 5u" GOLD
- 7: 15u" GOLD
- 9: 30u" GOLD

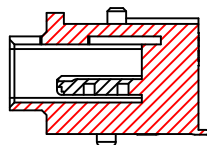
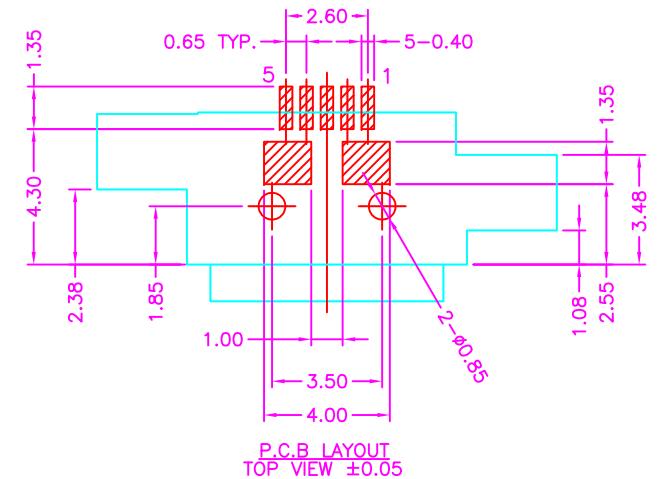
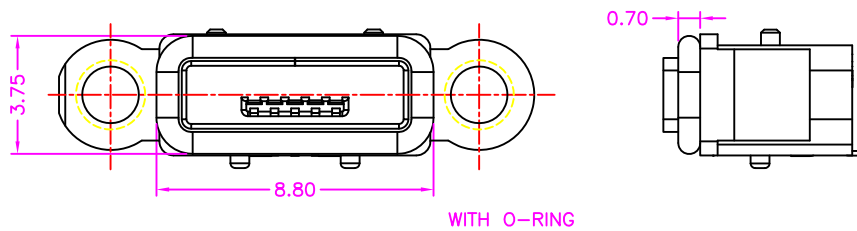

SECTION A-A

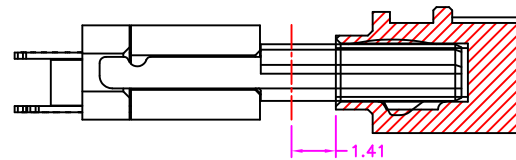

SECTION B-B

ASSEMBLY DRAWING