

A

A

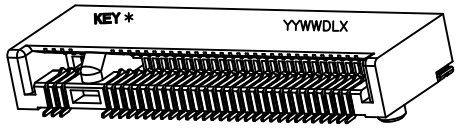

MATERIALS

HOUSING: HI-TEMP. PLASTIC (UL 94V-0), BLACK
 SOLDER PEG: STAINLESS STEEL, TIN PLATING
 TERMINAL: COPPER ALLOY, GOLD PLATED

SPECIFICATION

CURRENT RATING: 0.5 AMP MAX
 DIELECTRIC WITHSTANDING: 300V AC FOR ONE MINUTE
 CONTACT RESISTANCE: 55m OHMS MAX
 INSULATION RESISTANCE: 500M OHMS MIN AT DC 500V
 OPERATION TEMPERATURE: -40°C~+80°C

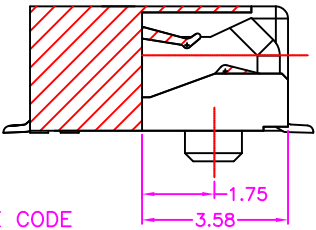
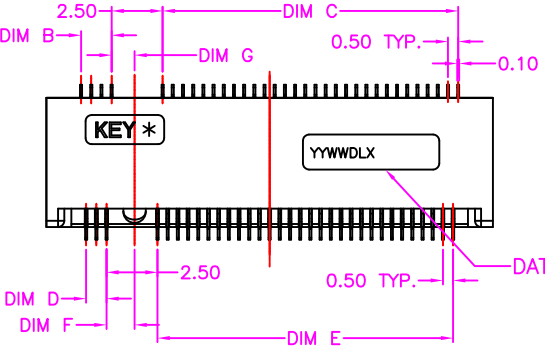

SECTION A-A
SCALE 2:1

PART NUMBER:

MCEGT - 6 7 * - 1 2 3 *

- SERIES
- NO. OF POS.
- CONTACT PLATED OPTION
- KEY TYPE OPTION
- A: A TYPE
- B: B TYPE
- C: C TYPE
- D: D TYPE
- E: E TYPE
- F: F TYPE
- G: G TYPE
- H: H TYPE
- J: J TYPE
- K: K TYPE
- L: L TYPE
- M: M TYPE

TAPE REEL PACKAGE

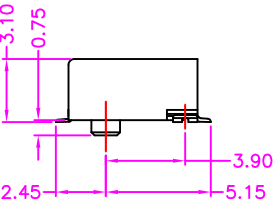
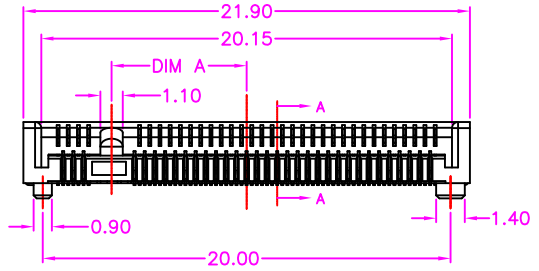

MATING SIMILAR
SCALE 2:1

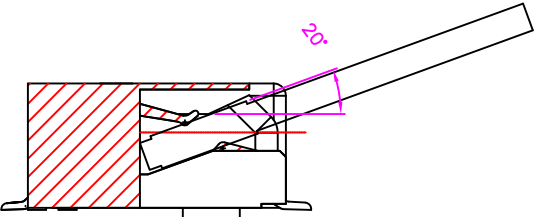
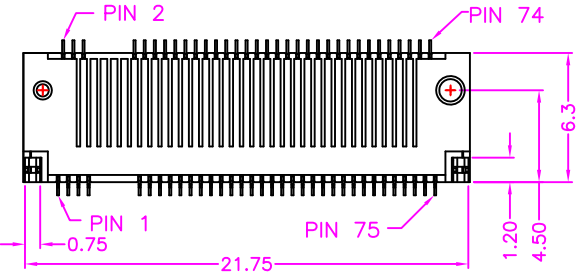

M	PIN 59-66	-6.125	14.0	2.0	14.0	1.5	1.125	1.375		
L	PIN 55-62	-5.125	13.0	3.0	13.0	2.5	1.125	1.375		
K	PIN 51-58	-4.125	12.0	4.0	12.0	3.5	1.125	1.375		
J	PIN 47-54	-3.125	11.0	5.0	11.0	4.5	1.125	1.375		
H	PIN 43-50	-2.125	10.0	6.0	10.0	5.5	1.125	1.375		
G	PIN 39-46	-1.125	9.0	7.0	9.0	6.5	1.125	1.375		
F	PIN 28-35	1.625	6.5	9.5	6.0	9.5	1.375	1.125		
E	PIN 24-31	2.625	5.5	10.5	5.0	10.5	1.375	1.125		
D	PIN 20-27	3.625	4.5	11.5	4.0	11.5	1.375	1.125		
C	PIN 16-23	4.625	3.5	12.5	3.0	12.5	1.375	1.125		
B	PIN 12-19	5.625	2.5	13.5	2.0	13.5	1.375	1.125		
A	PIN 8-15	6.625	1.5	14.5	1.0	14.5	1.375	1.125		
MODULE CARD TYPE	DIM P	KEY ID	PAD REMOVED	DIM A	DIM B	DIM C	DIM D	DIM E	DIM F	DIM G

B

B

C

C

D

D



TOLERANCES
 X.±0.40 .XX±0.20
 .X±0.30 .XXX±0.10

REV. A
 DRAWN BY Zhong 2018/12/21
 APPROVED BY Lion 2018/12/21

TITLE NGFF(M.2), 0.5mm PITCH, PCB MOUNT, SMT, 1 KEY WITH PAD H=3.20mm, FEMALE
 DRAW NO. MCEGT-003 UNIT MM Sheet 1/3

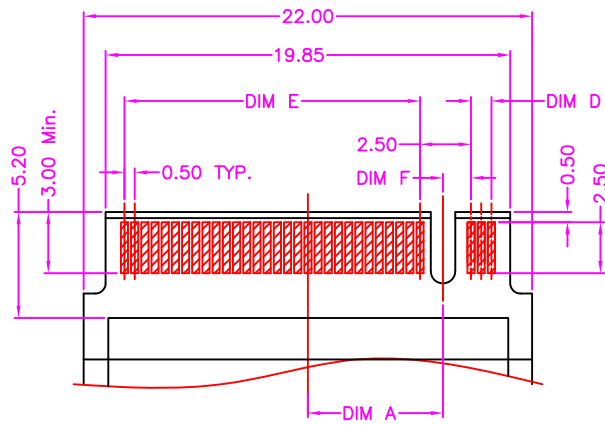

BOTTOM SIDE

PLUG PCB

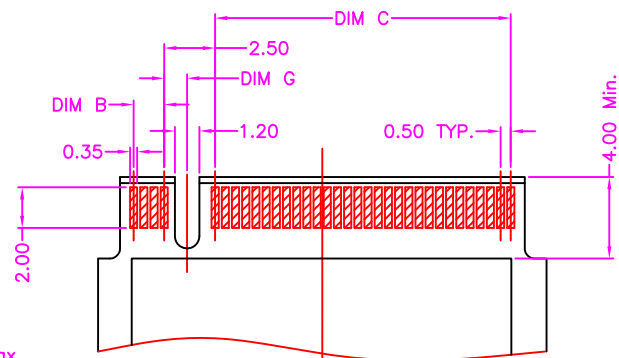
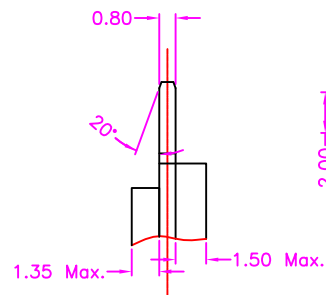

TOP SIDE

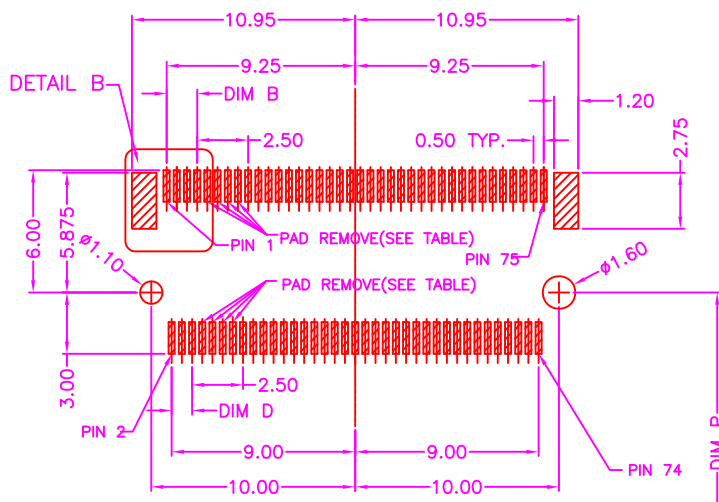

P.C.B. LAYOUT
TOP VIEW ± 0.05

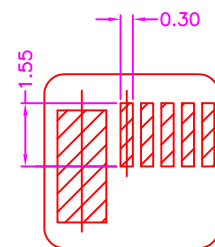

DETAIL B
SCALE 2:1

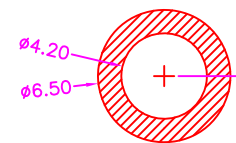

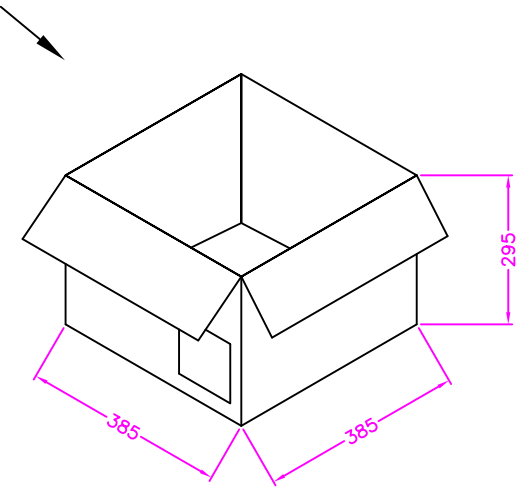
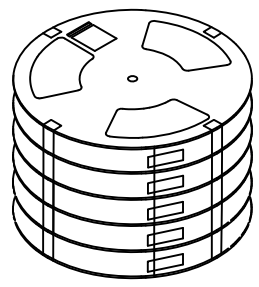
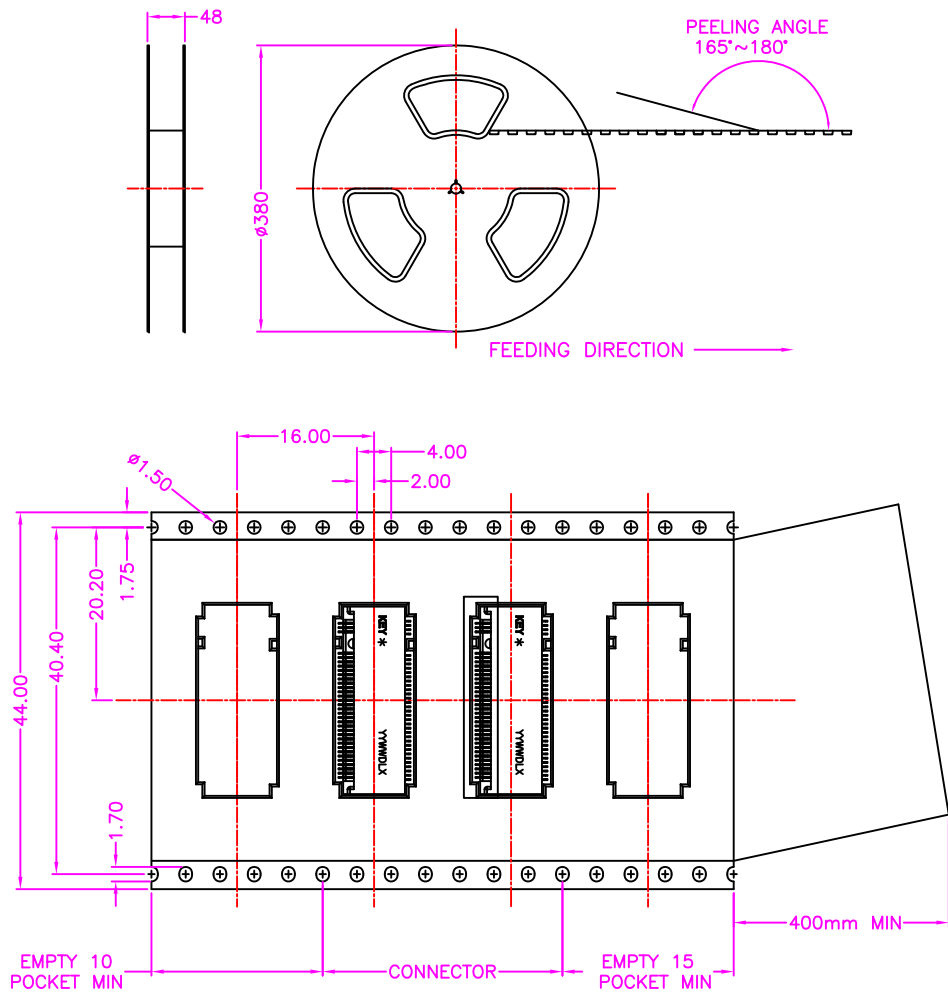

NOTE: 1400PCS/ REEL, 7000PCS/ 5 REEL/ CARTON

ZICONN
ELECTRONIC CO., LTD.
WWW.ZICONN.COM 886-3-4687695

TOLERANCES	
X.±0.40	.XX±0.20
.X±0.30	.XXX±0.10

REV.	A

DRAWN BY	Zhong 2018/12/21
APPROVED BY	Lion 2018/12/21

TITLE	NGFF(M.2), 0.5mm PITCH, PCB MOUNT, SMT, 1 KEY WITH PAD H=3.20mm, FEMALE				
DRAW NO.	MCEGT-003	UNIT	MM	Sheet	3/3