

A

A

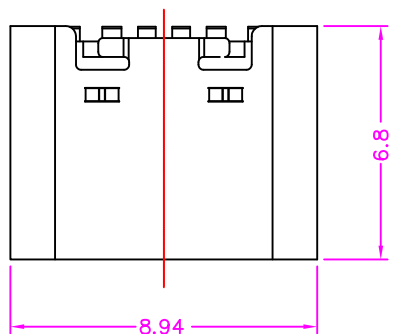

PART NUMBER:
BUSJB - 0 6 * - 1 2 N

SERIES ————
 NO. OF POS. ————
 CONTACT PLATED OPTION ————

TAPE REEL PACKAGE

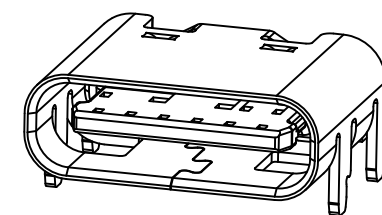

CONTACT PLATED OPTION
 1: 1u" GOLD
 3: 3u" GOLD
 5: 5u" GOLD
 6: 10u" GOLD
 7: 15u" GOLD
 9: 30u" GOLD

B

B

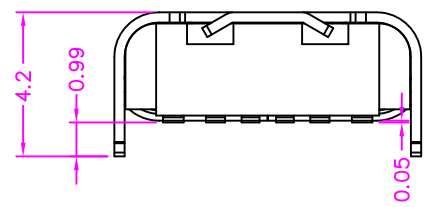
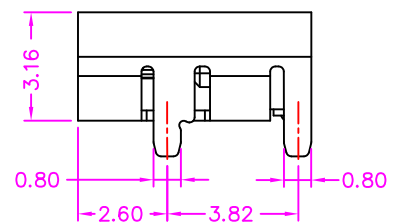
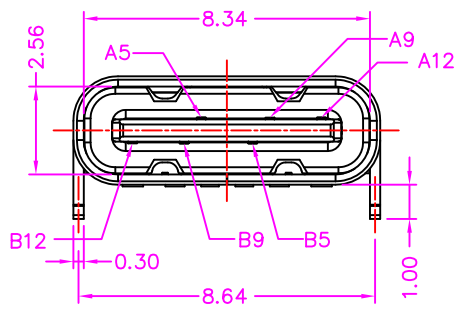

A5	CC1	B5	CC2
A9	VBUS	B9	VBUS
A12	GND	B12	GND
PIN	SIGNAL NAME	PIN	SIGNAL NAME

C

C

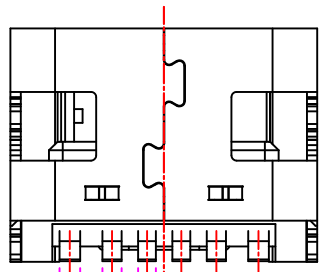

MATERIALS

HOUSING: HI-TEMP. PLASTIC (UL 94V-0), BLACK
 SHELL: STAINLESS STEEL, NICKEL PLATING
 TERMINAL: COPPER ALLOY, GOLD PLATED

SPECIFICATION

CURRENT RATING:
 1.5A/PIN MAX (A9,B9)
 1.25A/PIN MAX (A12,B12)
 0.25A FOR ALL THE OTHERS CONTACTS
 DIELECTRIC WITHSTANDING: 100V AC FOR ONE MINUTE
 CONTACT RESISTANCE: 40m OHMS MAX
 INSULATION RESISTANCE: 100M OHMS MIN AT DC 300V
 OPERATION TEMPERATURE: -40°C~+85°C

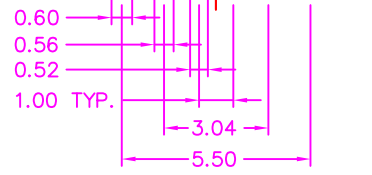
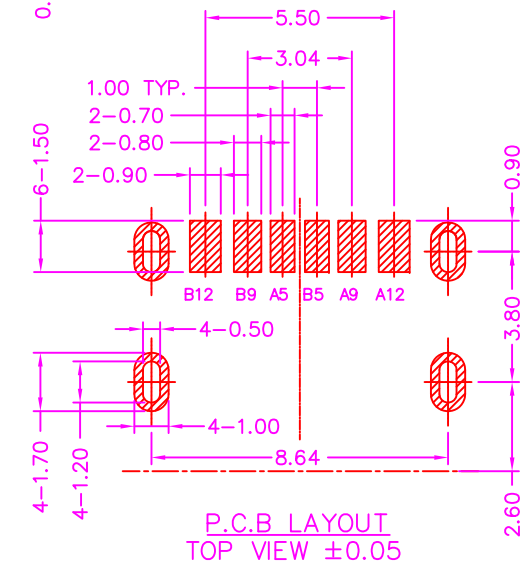

D

D



TOLERANCES

X±0.40	.XX±0.20
.X±0.30	.XXX±0.10

REV.	A	DRAWN BY	Zhong 2021/11/23	TITLE	USB C TYPE, PCB MOUNT, SMT, METAL SHIELD, 6PIN, FEMALE				
		APPROVED BY	Lion 2021/11/23	DRAW NO.	BUSJB-022	UNIT	MM	Sheet	1/1

BUSJB-022	UNIT	MM	Sheet	1/1
-----------	------	----	-------	-----