

CONTACT PAD

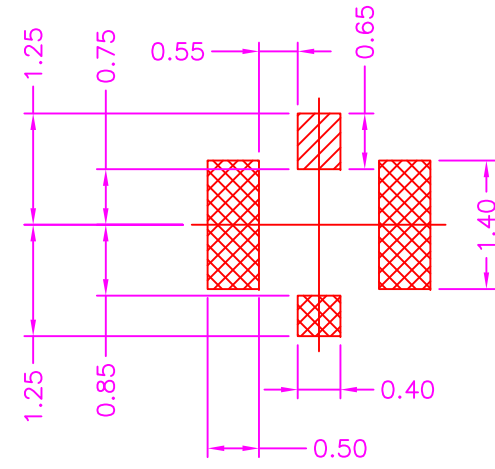

P.C.B. LAYOUT
TOP VIEW ±0.05

CONTACT PAD SHELL PAD

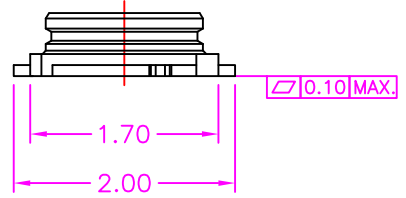
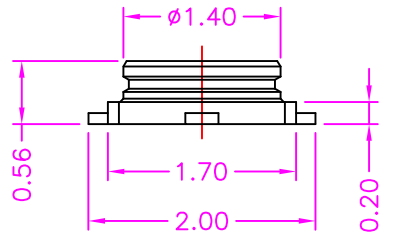
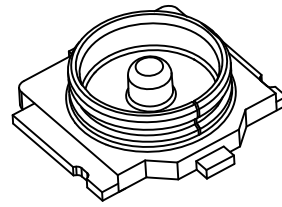
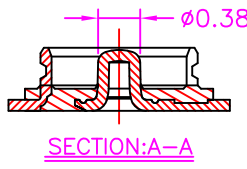
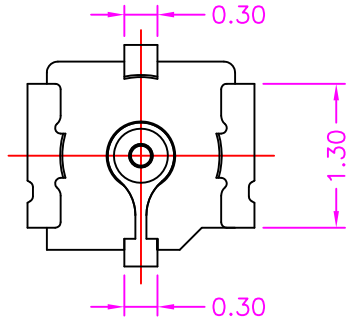

MATERIALS

HOUSING: HI-TEMP. PLASTIC (UL 94V-0)
TERMINAL: COPPER ALLOY, GOLD PLATED

SPECIFICATION

DIELECTRIC WITHSTANDING: 200V AC FOR ONE MINUTE
CONTACT RESISTANCE: 20m OHMS MAX
INSULATION RESISTANCE: 500M OHMS MIN AT DC 100V
OPERATION TEMPERATURE: -40°C~+90°C

PART NUMBER:

RPXCA - 0 * * - 2 2 4

SERIES TAPE REEL PACKAGE

GROUND CONTACT PLATED OPTION

- 1: GOLD FLASH
- 3: 3u" GOLD
- 5: 5u" GOLD
- 9: 30u" GOLD
- S: SILVER

CENTER CONTACT PLATED OPTION

- 1: GOLD FLASH
- 3: 3u" GOLD
- 5: 5u" GOLD
- 9: 30u" GOLD
- S: SILVER



TOLERANCES	
X.±0.40	.XX±0.20
.X±0.30	.XXX±0.10

REV.	A	DRAWN BY	Kiki 2022/3/28	TITLE	MICRO COAXIAL (MODEL 5), SMT, MALE				
		APPROVED BY	Lion 2022/3/28	DRAW NO.	RPXCA-004	UNIT	MM	Sheet	1/1

1 2 3 4 5 6

A

A

PACKING DIRECTION

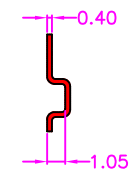
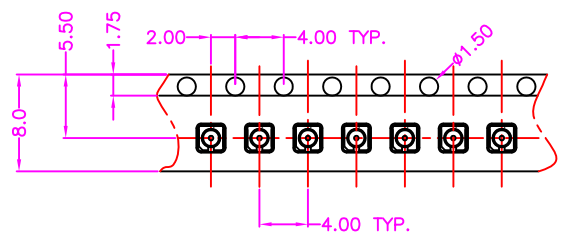
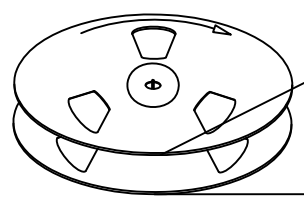

B

B

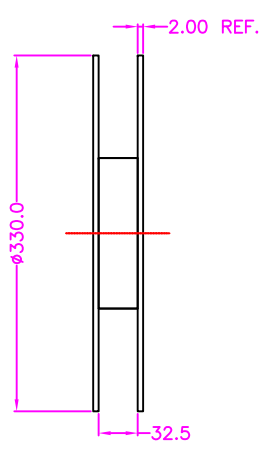

PROTECT TAPE

COVER TAPE

PRODUCT

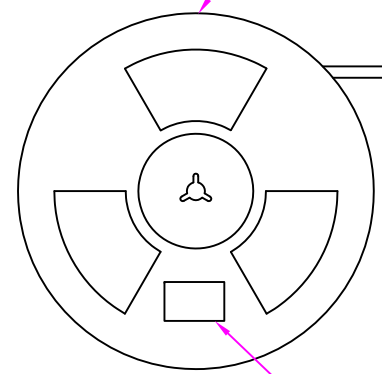

PULL DIRECTION

LABEL

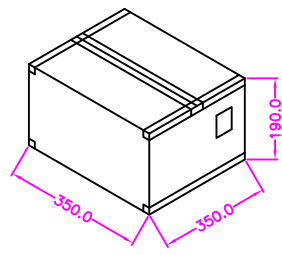
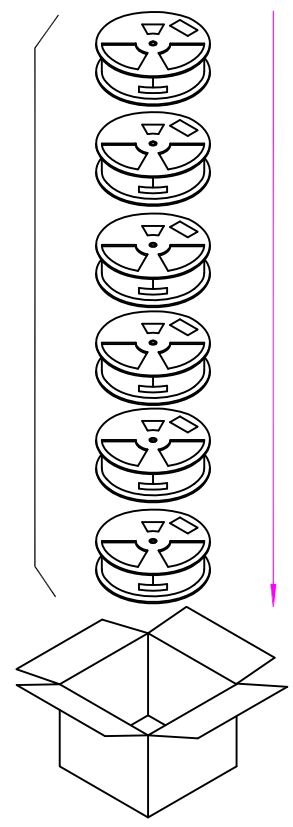

NOTE: 10000PCS/ REEL, 100000PCS/ 10 REEL/ CARTON

D

D

ZICONN
ELECTRONIC CO., LTD.
WWW.ZICONN.COM 886-3-4687695

TOLERANCES	
X.±0.40	.XX±0.20
.X±0.30	.XXX±0.10

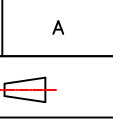
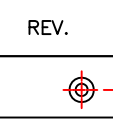

REV.	A	DRAWN BY	Kiki 2022/3/28	TITLE	MICRO COAXIAL (MODEL 5), SMT, MALE				
APPROVED BY	Lion 2022/3/28	DRAW NO.	RPXCA-004	UNIT	MM	Sheet	2/2		

1 2 3 4 5 6