

MATERIALS

HOUSING: HI-TEMP. PLASTIC (UL 94V-0), BLACK
 SHELL: COPPER ALLOY, NICKEL PLATING
 TERMINAL: COPPER ALLOY, GOLD PLATING ON CONTACT AREA
 TIN PLATING ON SOLDER TAIL

SPECIFICATION

CURRENT RATING: 1 AMP MAX
 DIELECTRIC WITHSTANDING: 100V AC FOR ONE MINUTE
 CONTACT RESISTANCE: 50m OHMS MAX
 INSULATION RESISTANCE: 100M OHMS MIN AT DC 100V
 OPERATION TEMPERATURE: -40°C~+85°C

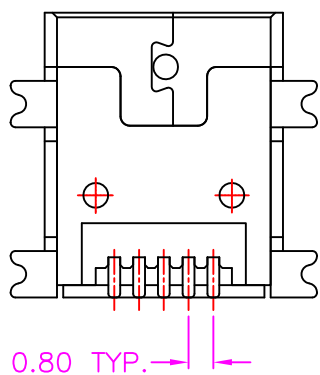
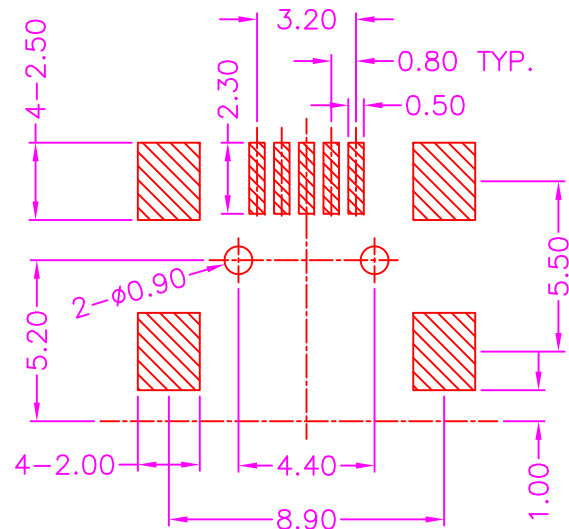
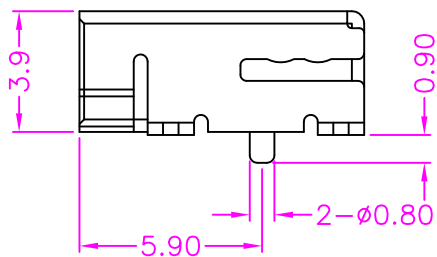
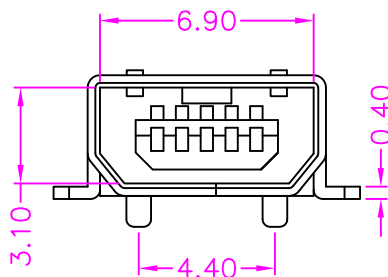

PART NUMBER:

BUSMC - 0 5 * T - 1 * 2

SERIES

NO. OF POS.

CONTACT PLATED OPTION

- 1: GOLD FLASH
- 3: 3u" GOLD
- 5: 5u" GOLD
- 6: 10u" GOLD
- 9: 30u" GOLD

PACKAGE OPTION

- 1: TRAY
- 2: TAPE REEL
- 3: TUBE

TIN PLATING ON SOLDER TAIL

P.C.B. LAYOUT
 TOP VIEW ±0.05

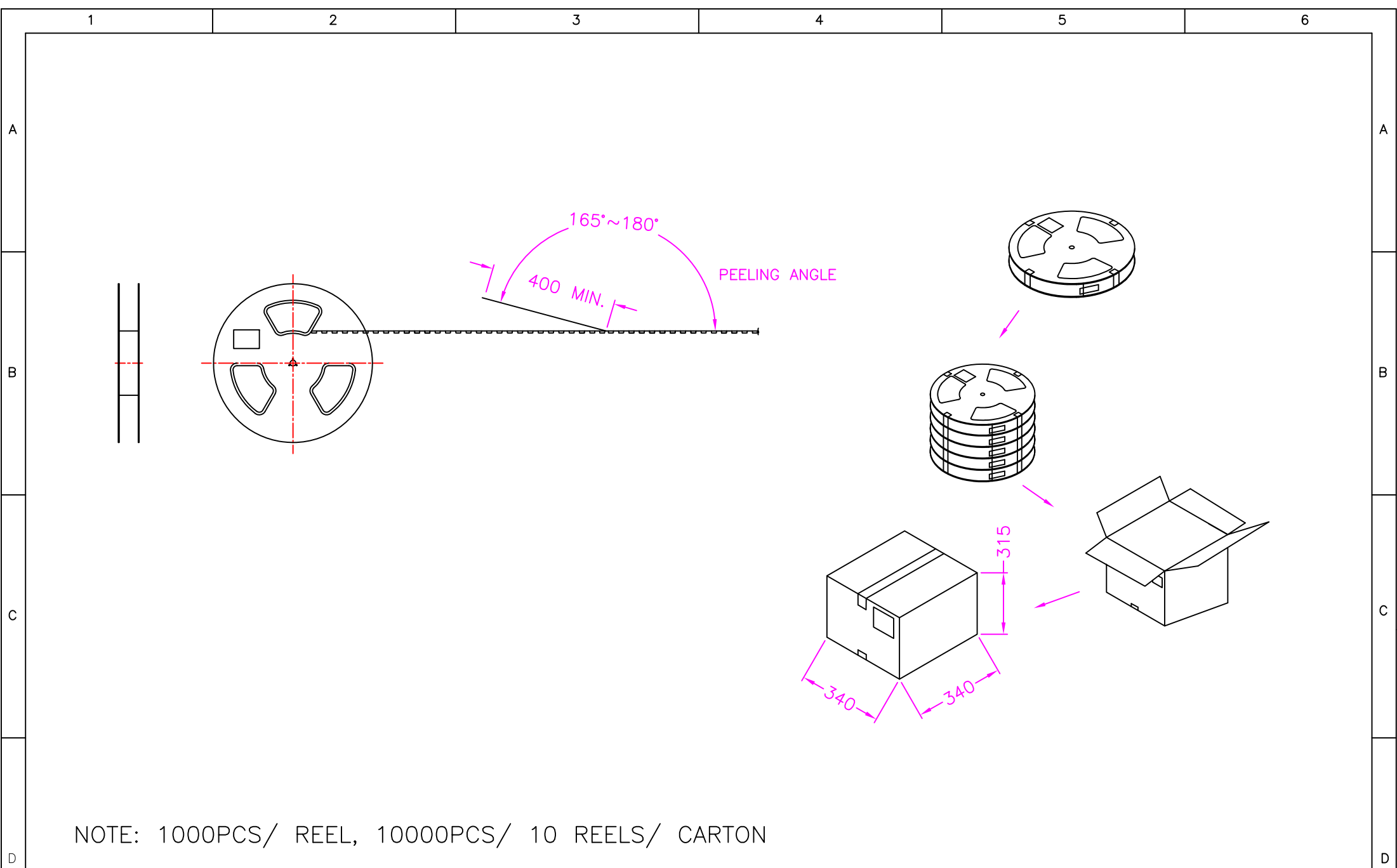

NOTE: 1000PCS/ REEL, 10000PCS/ 10 REELS/ CARTON

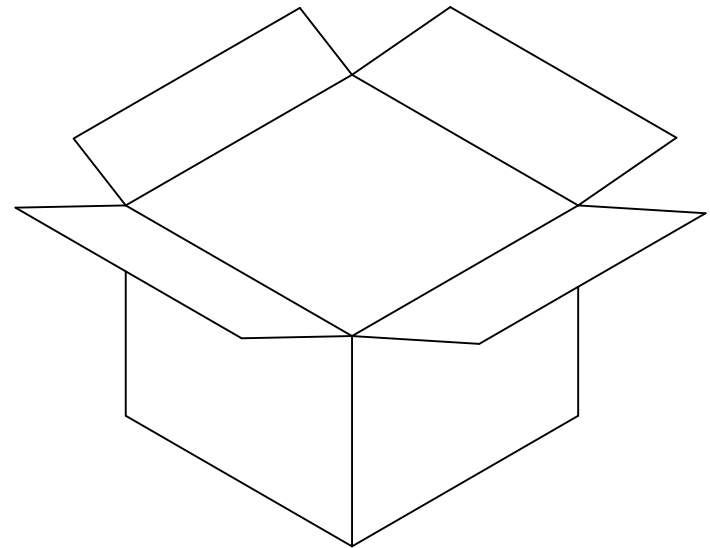
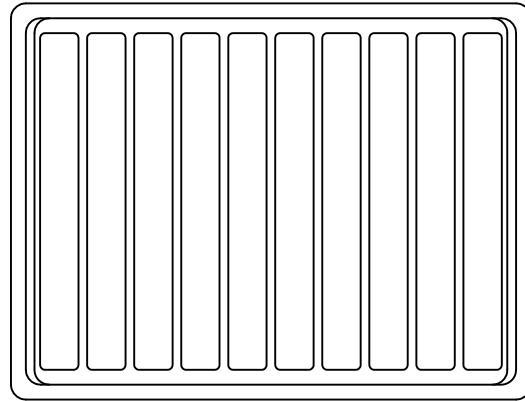
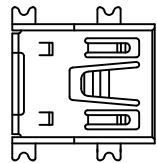

NOTE: 100PCS/ TRAY, 10000PCS/ 100 TRAY/ CARTON