

**MATERIALS**

HOUSING: LCP (UL 94V-0), BLACK  
 CAP: LCP (UL 94V-0), BLACK  
 SHELL: STAINLESS STEEL, NICKEL PLATING  
 TERMINAL: COPPER ALLOY, GOLD PLATED

**SPECIFICATION**

CURRENT RATING:  
 1.5A/PIN MAX (A9,B9)  
 1.5A/PIN MAX (A12,B12)  
 0.25A FOR ALL THE OTHERS CONTACTS  
 DIELECTRIC WITHSTANDING: 100V AC FOR ONE MINUTE  
 CONTACT RESISTANCE: 40m OHMS MAX  
 INSULATION RESISTANCE: 100M OHMS MIN AT DC 300V  
 OPERATION TEMPERATURE: -40°C~+85°C

WITH CAP

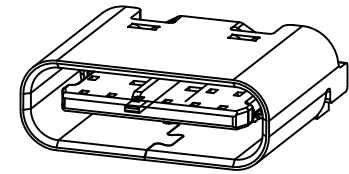
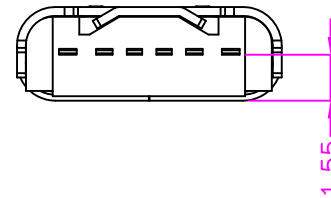
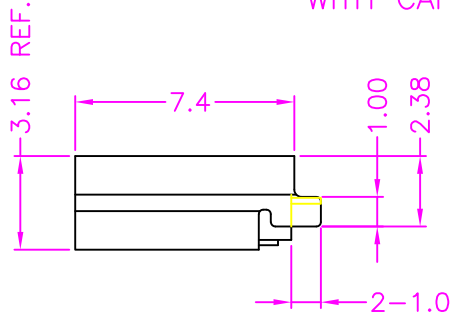
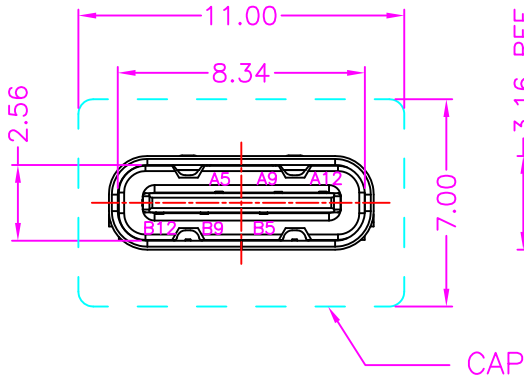

CAP

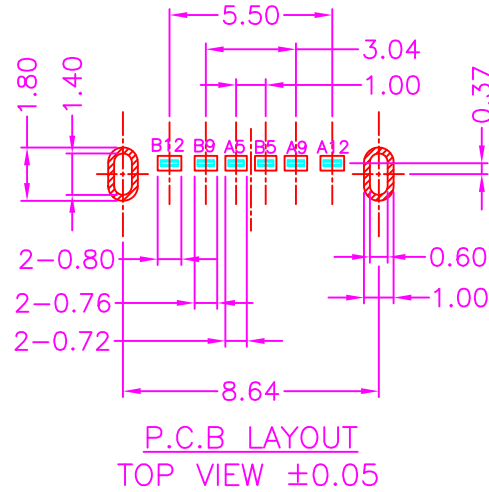
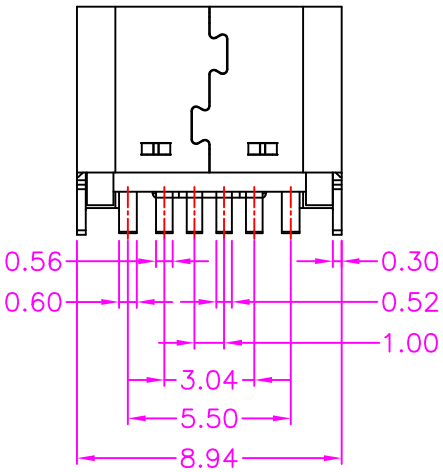

**PART NUMBER:**

BUSJA - 0 6 \* - 1 2 7

SERIES

NO. OF POS.

TAPE REEL PACKAGE

**CONTACT PLATED OPTION**

- 1: GOLD FLASH
- 3: 3u" GOLD
- 5: 5u" GOLD
- 6: 10u" GOLD
- 7: 15u" GOLD
- 9: 30u" GOLD

**PIN ASSIGNMENTS**

PIN	SIGNAL NAME	PIN	SIGNAL NAME
A5	CC1	B12	GND
A9	VBUS	B9	VBUS
A12	GND	B5	CC2

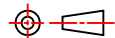

REEL OFF SECTION 600PCS REEL OFF SECTION

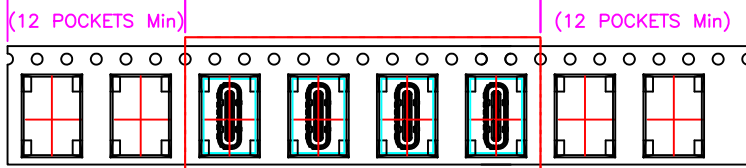

SEE DETAIL X

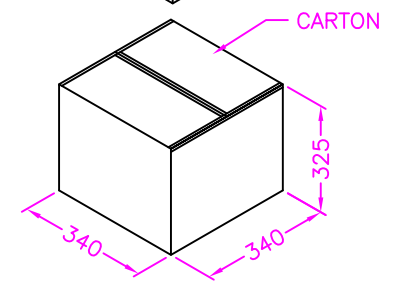
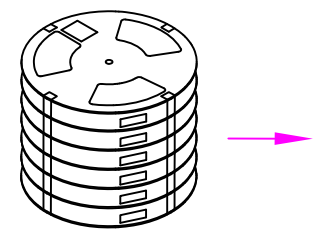
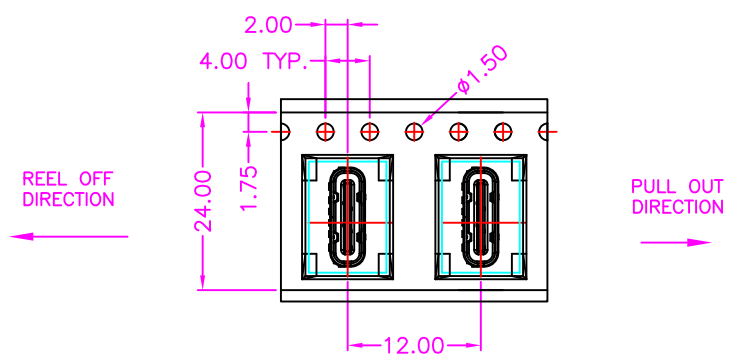
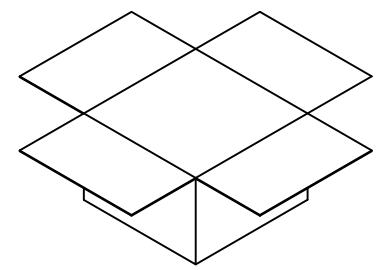
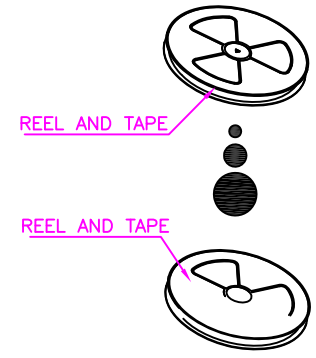
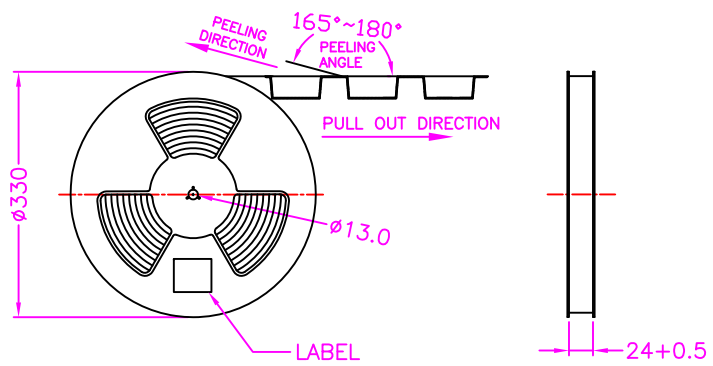

NOTE: 600PCS/ REEL, 6600PCS/ 11 REEL/ CARTON



TOLERANCES	
X.±0.40	.XX±0.20
.X±0.30	.XXX±0.10

REV.	A

DRAWN BY	Kiki 2023/3/18
APPROVED BY	Lion 2023/3/18

TITLE	USB C TYPE, PCB MOUNT, VERTICAL, METAL SHIELD, 6PIN, FEMALE				
DRAW NO.	BUSJA-007	UNIT	MM	Sheet	2/2